

felkapaszkodó rendszer a jelenlegi földémmagasságokban,
 határozott vonalvezetés
 szögtört közlekedő szalag az épület szigorúságára reagálva
 a belógó falak szintről szintre való kerülgetése
 a fal hosszirányú átlátást biztosít
 belesimul a vezéirányba

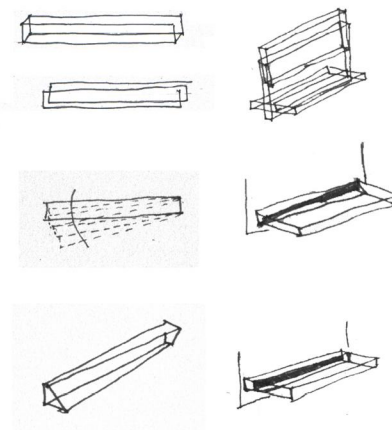

bejárat formakeresés



kígyózó rendszerek

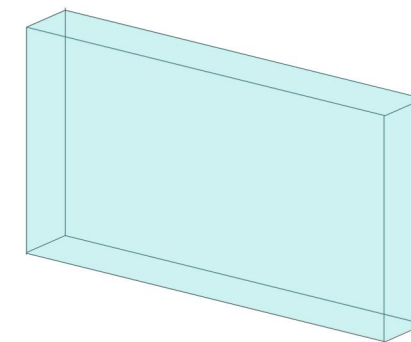
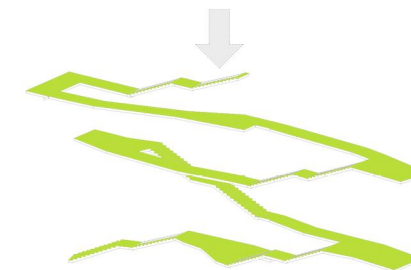
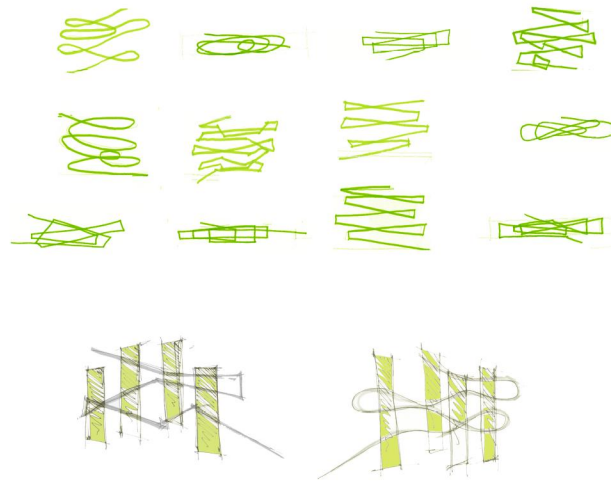

bejutási irány kijelölése

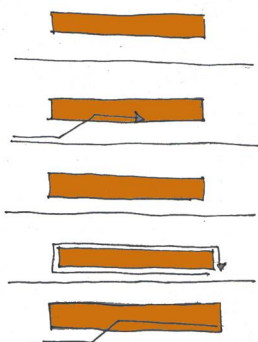

kicsúszó földém az utcára nyitva

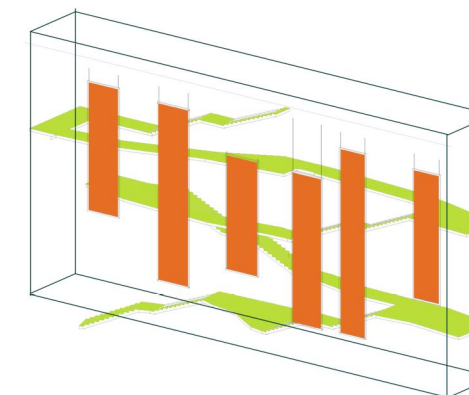
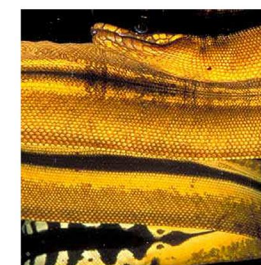
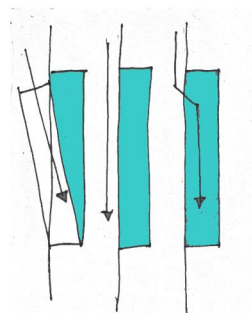

új-régi

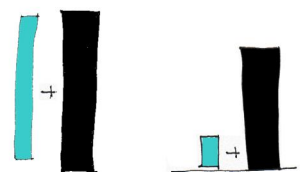

bejárat portál tömegformálás



E-O3

konceptió
 Formatur
 Bp. Rumbach S. utca 5.
 Vízkelety Rita
 DIPLOMATERV
 2011

